

Installation, Operation and Maintenance Manual

for Improved Water Mill at Ramtoli

Prepared for

TIFAC-DST Sponsored Project

Development of Standard Water Mills in Uttarakhand



Submitted to

TIFAC (Uttarakhand Mission)
Department of Science & Technology
Government of India

Prepared by

Alternate Hydro Energy Centre
Indian Institute of Technology Roorkee
Roorkee - 247 667

October 2005

TABLE OF CONTENT

Sl. No. Items	Page No.
1.0 PREFACE	1
2.0 TRADITIONAL WATER MILL	1
3.0 IMPROVED WATER MILL	2
3.1 Runner	2
3.2 Drive Shaft	2
3.3 Bottom Bearing	2
3.4 Wooden Bush	3
3.5 Rynd or Cam	3
3.6 Upper Stone Lift Mechanism	3
3.7 Grinding Stones	3
3.8 Flume/Chute	3
3.9 Feeding Mechanism	3
4.0 INSTALLATION PROCEDURE	4
4.1 Step I : Ensure the Tools	4
4.2 Step II : Dismantling of Traditional Water Mill Components	4
4.3 Step III : Fitting of Bottom Bearing	4
4.4 Step IV : Shaft Fixing with Runner	4
4.5 Step V : Fitting the Remaining Components	5
4.6 Step VI : Alignment of Water Jet	5
5.0 OPERATION	5
6.0 MAINTENANCE	7
6.1 Maintenance of Chute Inlet	7
6.2 Maintenance of Water Chute	7
6.3 Bottom Bearing Ball	7
6.4 Alignment of the Shaft	7
6.5 Stones Dressing	8

INSTALLATION, OPERATION AND MAINTENANCE MANUAL

1.0 PREFACE

In the hills water mills, commonly known as 'gharats' have significant role in utilisation of mechanical power from water streams, mainly for grinding purpose. The design of traditional gharat is quite old and very little modification has been done over the years in the gharat designs. Throughout the Himalayan ranges from Kashmir to Arunachal Pradesh, thousands of water mills are being used for grinding cereals. By the input of technical enrichment the efficiency of traditional water mill can be increased upto 3 times. Alternate Hydro Energy Centre (AHEC), Indian Institute of Technology Roorkee (IITR), Roorkee has been involved in development of water mills. Based upon the field experiences an improved water mill for upgradation has been developed. These upgraded water mill can be used to generate the electricity if connected to a low capacity generation say about 1.0 to 2.0 kW. This manual provides the guidelines for installing the vertical shaft water mill for grinding and electricity generation.

2.0 TRADITIONAL WATER MILL

Traditional water mill consists of a wooden turbine with straight wooden blades, fitted inclined to a thick vertical wooden shaft tapering at both ends. The water chute consists of an open channel either made from wooden planks or carved from a large tree trunk. The chute is narrowed down toward the lower end forming a nozzle. The wooden shaft of the turbine is supported on a stone pivot through a steel pin and held in the sliding bearing at the top. The sliding bearing is a wooden bush fixed in the lower stationary grinding stone. The top grinding wheel rests on the lower stone and is rotated by the turbine shaft through a straight slot coupling. The gap between the stone is adjusted by lifting the upper stone with the help of lift mechanism.

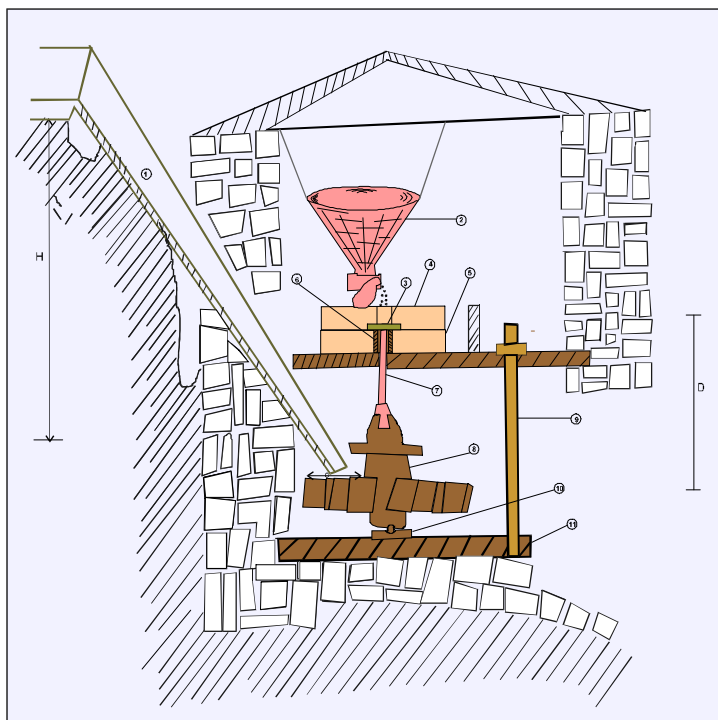

No.	Description
1.	Flume
2.	Hopper
3.	Rynd/Cam
4.	Upper Grinding Stone
5.	Lower Grinding Stone
6.	Upper Bearing/Bush
7.	Shaft
8.	Runner with Hub
9.	Lifting Mechanism Lever
10.	Bottom Bearing
11.	Lifting Mechanism Bar
L	Chute Length
H	Head
C	Runner Radius
D	Shaft Length

3.0 IMPROVED WATER MILL

A vertical shaft Water Mill upto 3 kW mechanical output has been developed by AHEC under the Project sponsored by DST-TIFAC Govt. of India. The developed system is capable to provide an efficient and long life machine useful for grinding cereals at a faster rate with minimal maintenance. The improved runner ensures the enhancement of efficiency by 3-5 times over the traditional water mill and also generate electricity. The improved runner is very easy to install and can be fitted with other parts of the existing water mills which are generally found in good conditions and do not have significant effect on the output of the water mill. The parts of the machines are very simple and are easy to understand by local people. The newly designed water mill consists of the following components :

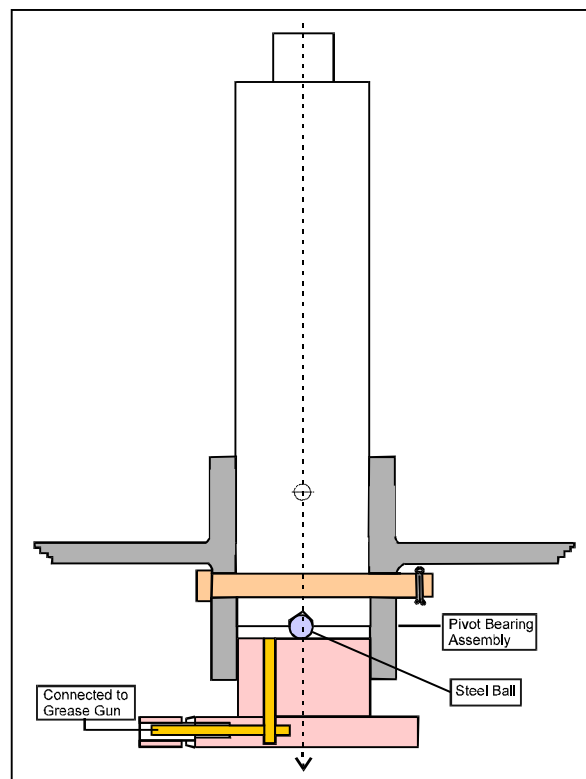

Improved Water Mill

3.1 Runner

The diameter of the runner is about 500 mm having 16 blades. The complete runner is cast in single-piece and having about 30 kg.

3.2 Drive Shaft

A steel shaft of 50 mm diameter has been used as a drive shaft. The upper end of the shaft is cut in rectangular form to fit the rynd/cam for upper stone attachment.

3.3 Bottom Bearing

A very simple bottom bearing having a ball which is press fitted at the lower end of the shaft, which rests on a piece of hard steel.

3.4 Wooden Bush

A simple oil soaked wooden bush made of hard wood is used in the upper stone hole to hold the shaft straight and aligned vertical.

3.5 Rynd or Cam

Cam is used for revolving the upper stone over the bottom stone fitted with driving shaft.

3.6 Upper Stone Lift Mechanism

The lift mechanism is a steel bar having a rotating wheel at its upper end and pin at lower end. The lower end is fitted to the cross bar with the help of the pin.

3.7 Grinding Stones

Existing grinding stones can be used for new installation as these are found, generally in good conditions.

3.8 Flume/Chute

The existing flume can be reused by providing the lining of G.I.

3.9 Feeding Mechanism

At existing sites feeding mechanism consists of a hopper with a vibrator can be reused.

The improved runner installed at Ramtoli site, is as shown below ;



Improved Runner

4.0 INSTALLATION PROCEDURE

4.1 Step I : Ensure the Tools

To enable the installation of the improved system well maintained and good quality tools are essential. First of all, check all the tools such as; Hammer, Sheet cutter, File, Grease Gun, Hacksaw, Plumb, Screw driver, Draw bar, Sprit level, Spanner, Wood saw, Chisels.

4.2 Step II : Dismantling of Traditional Water Mill Components

The components of traditional water mill should be dismantled in order to fit the improved components.

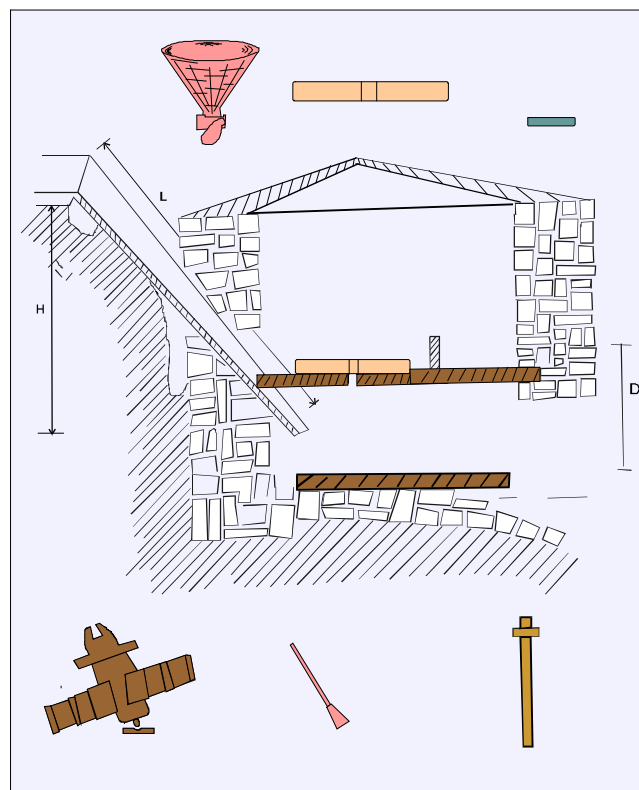

4.3 Step III : Fitting of Bottom Bearing

To ensure the shaft alignment in proper vertical position with respect to the cross bar over foot bearing at lower end and upper grinding stone at upper end, a centre mark should be made on the cross bar. Taking this mark as the centre of bottom bearing spindle, the plate of bearing is fixed by putting the nails with the cross bar.

4.4 Step IV : Shaft Fixing with Runner

After placing runner over the bottom bearing from down stream side, place the shaft through the hole of lower grinding stone from upstream side. After alignment of shaft with the runner put the pin through the holes of runner hub and shaft in order to

fit the runner with the shaft. Now put the wooden bush inside the hole of lower grinding stone over the shaft.

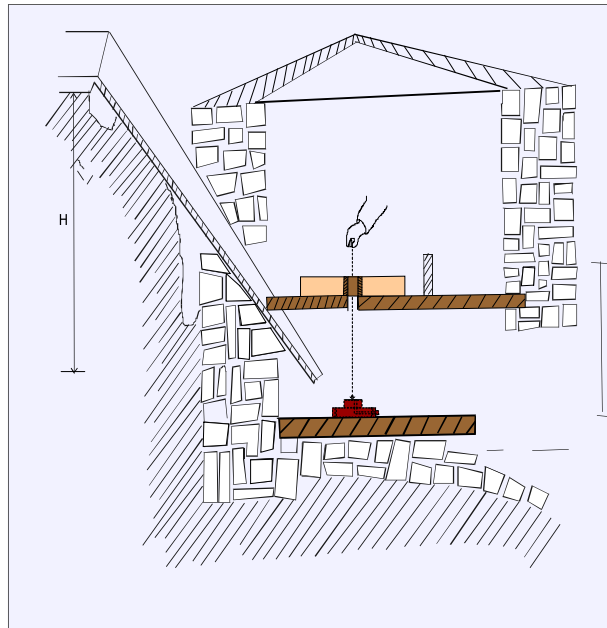

4.5 Step V : Fitting the Remaining Components

After fitting the runner with the shaft, fix the rynd at the upper end of the shaft and place the upper grinding stone over the lower grinding stone. Fix all the remaining components.

4.6 Step VI : Alignment of Water Jet

Alignment of the chute is one of the essential requirement of the water mill installation. In case of the new runner water jet must strike 3 blades at inside of the runner. Water flow from inside to outside direction as the runner is 'outward' flow type.

5.0 OPERATION

Correct operation of the system is beneficial in many ways. Managers and operators must be fully familiar with the equipment, its functions a operational procedures. Technical specifications must also be known and properly recorded in the Operations & Maintenance Manual provided by the installer.

The following checks should be made during starting, stopping and running of unit. At any stage if a problem is noticed; say, unusual sound, the unit should be stop problem rectified before starting or running the unit.

- (a) Follow the specified procedure for cleaning up the civil works as applicable.
- (b) Visually inspect all component (e.g. Bottom bearing, Runner, Shaft, Pin, bush, stones, hopper, lift mechanism and vibrator etc.)
- (c) Ensure that jet of water aimed properly to the runner blades.

- (d) Keep sufficient gap between stones to rotate upper stone smoothly in the beginning.
- (e) Increase the discharge slowly so that stone along with the wheel pick up the speed.
- (f) By operating lift mechanism keep the gap as desired based on the quality of flour is required.

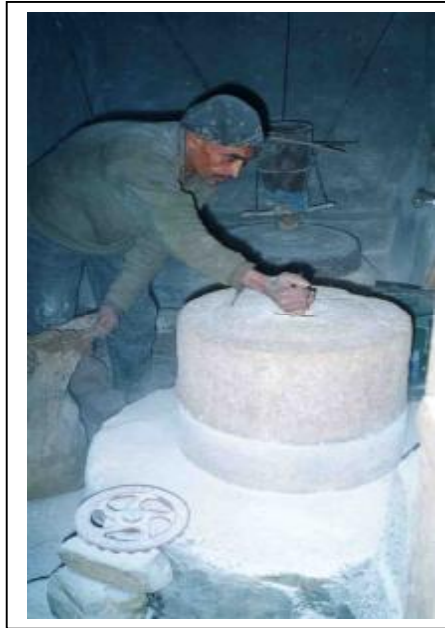

Water Mill under operation at Ramtoli for grinding

For electricity generation following steps should be followed for operating the unit.

- (a) Check that all switches on the load side are in the "OFF" position.
- (b) Inform users that unit will be starting.
- (c) If belts are removed, put them on the pulleys, check belt tension also.
- (d) Gradually let water into the turbine by opening the turbine valve.
- (e) If there are any push button switches for exciting the generator, press the voltage rises up to 200 V.
- (f) Increase water flow by opening turbine valves further until the speed, and power comes up to desirable/rated level.

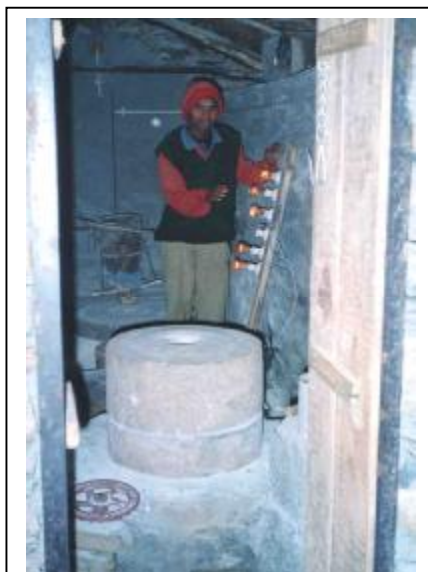

Water Mill in operation at Ramtoli for lighting purpose

6 MAINTENANCE

6.1 Maintenance of Chute Inlet

To make the flow smooth from power channel to the chute the joint should be maintained properly.

6.2 Maintenance of Water Chute

With use, the surface of water chute gets worn out and the surface in contact with water becomes rough, having loss of head due to friction. Try to make this surface smooth by maintaining it properly.

6.3 Bottom Bearing Ball

The alignment of the shaft, some time gets disturbed, due to the thrust of the water jet through chute. This misalignment results in the wobbling in the runner. This may damage the foot bearing and hub of the runner. It is suggested to the owner/operator that he should check the alignment of the shaft regularly, if there is any misalignment then find out the cause and rectified it immediately.

6.4 Alignment of the Shaft

The bottom bearing ball fitted with the shaft revolves over the foot bearing spindle. This ball worn out over a period of time. The replacement of the ball with new one is required. However life of the ball may be increased by providing proper lubrication. Owner/ operator must ensure the lubrication before starting the system. At the end of the shaft, a hole has been embedded. By striking the nail with hammering device the ball inside the hole in the shaft is drawn outside. For inserting the new ball in the given hole of the shaft the wooden batten is stroked on the outer surface of the shaft. Procedures of the replacing the ball is shown as below.

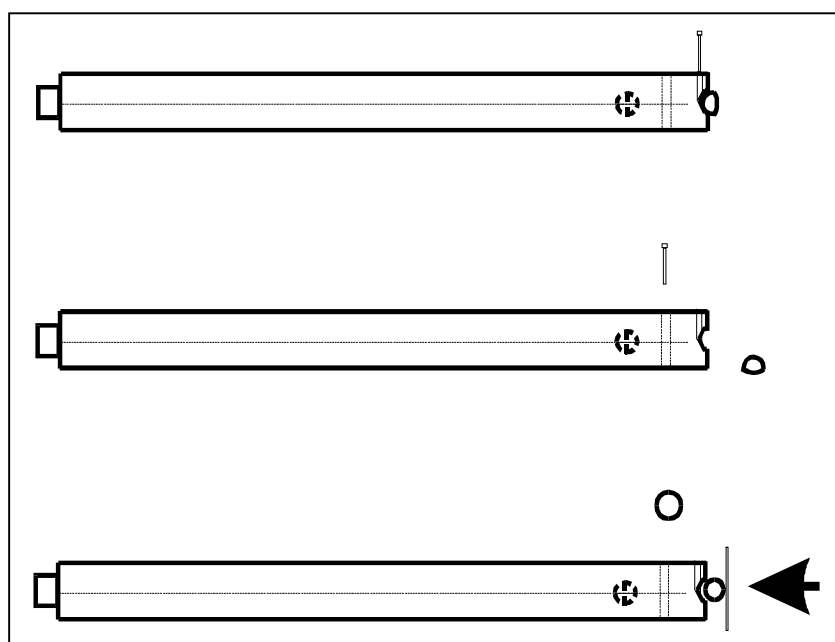

6.5 Stones Dressing

Dressing of stones is very important to increase the output of the water mills. Stones grooving are necessary to be made scientifically. It is very necessary that grooves should be maintained time to time and proper.

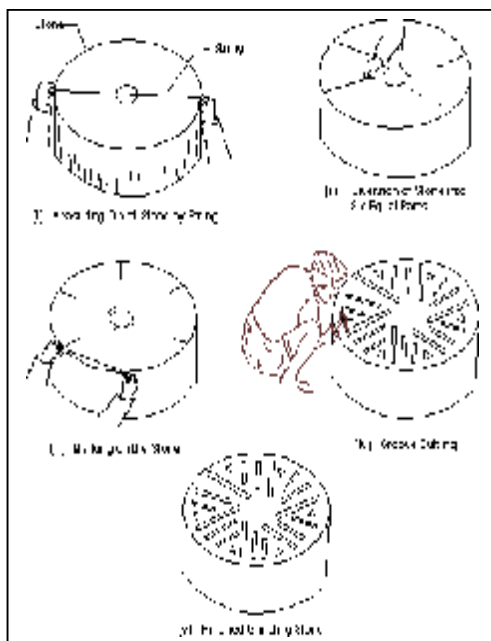

Properly dressed stone at Ramtoli

The maintenance of the system should be monitored properly by filling the performa given in Table below ;

Item	Daily	Weekly	Monthly	Observations/Action Taken
Power Canal				
Foreign objects in channel		√		
Correct flow level in channel	√			
Leakage from channel		√		
Flume				
Leakage in Flume	√			
Alignment of nozzle with runner	√			
Upper Grinding Stone				
Conditions of grooves/dressing		√		
Lower Grinding Stone				
Condition of grooves/dressing		√		
Rynd				
Fitting with upper stone	√			
Fitting with coupling of gearbox	√			

Bush				
Clearance over shaft			√	
Fitting with lower stone			√	
Shaft				
Alignment with stone			√	
Alignment with runner			√	
Alignment with bottom bearing			√	
Runner				
Condition of blades			√	
Fitting of hub with shaft through pin			√	
Bottom Bearing				
Greasing/oiling		√		
Surface of ball			√	
Surface of spindle			√	
Hopper				
Mounting of hopper			√	
Walls surfaces of hopper			√	
Vibrator				
Tightening with hopper			√	
Contact with upper stone		√		
Drive system				
Drive pulley		√		
Driven pulley		√		
Drive belt tension		√		
Drive belt condition			√	
Generator				
Check generator bearings for vibration	√			
Generator bearings not overheating	√			